

GB

User Guide  
0-15Kg (0-4 yrs)

**Britax**



*Visio*

**Important!**

Children up to 15kg (approx. 4 years)



*Read these instructions carefully before use and keep them for future reference. Your child's safety may be affected if you do not follow these instructions.*

## Please read this User Guide carefully BEFORE trying to use your pushchair

### Looking after your pushchair

The pushchair and its cover have been carefully designed, manufactured and tested to high safety standards.

Regularly inspect and maintain your pushchair to ensure freedom of movement of the joints, locking devices and security of components. To prolong the life of your pushchair, keep it clean and do not leave it in direct sunlight for extended periods of time.

### Cleaning the cover

The seat cover is removable and can be washed in accordance with the washing instructions on the label.

The hood and trims may be cleaned using warm water with household soap or mild detergent. Allow it to dry fully, preferably away from direct sunlight.

**DO NOT** dry clean or use bleach or any other aggressive cleaning agents.

### IMPORTANT MAINTENANCE ADVICE

If the wheels squeak use a silicon based spray or light lubricating oil ensuring it penetrates the wheel and axle assembly.

Regularly clean and lubricate the front swivel and wheel units as dirty or dry units can have an adverse effect on manoeuvrability and steering.

When using the Stroller on the beach, clean it completely afterwards to remove all the sand and salt from the mechanisms and wheel assemblies.

If there are compression marks or indentations on the tyres – use a domestic hair dryer to gently warm the area. This should help make them disappear. (DO NOT OVERHEAT).

Under certain climate conditions the covers and trims may be affected by mould and mildew. To help prevent this occurring, do not fold or store this Stroller if it is wet or damp. Always store in a well ventilated area.

To maintain the safety of your Stroller, seek prompt repairs for bent, torn or broken parts. Use only those parts and accessories approved by Britax.

Replacement parts and accessories are available from your Britax stockist or contact Britax Customer Service Department on 01264 386034.

This product is not intended for commercial use.

**WARNING** – Use a harness as soon as your child can sit unaided.

**WARNING** – Any load attached to the handle affects the stability of the pushchair.

**Warnings & Guarantee**

WARNING – A CHILD'S SAFETY IS YOUR RESPONSIBILITY



**WARNING** – This vehicle is only intended for children from birth and up to 15kg.

**WARNING** – This vehicle is not suitable for running or skating.

**WARNING** – It may be dangerous to leave your child unattended.

**WARNING** – Ensure that all locking devices are fully engaged before use.

**WARNING** – Use a harness as soon as your child can sit unaided.

**WARNING** – Overloading, incorrect folding and the use of non-approved accessories may damage or break this pushchair and make it unstable for use.

**WARNING** – Regularly inspect the pushchair to ensure all parts are in full working order.

**DO NOT** Do not add an additional mattress thicker than 15 mm in place of the infant comfort pad, when used in infant carrier mode.

**DO NOT** allow the pushchair to remain wet for prolonged periods of time. If it does get wet, allow to dry unfolded at room temperature.

**DO NOT** carry more than 2kg in the shopping basket.

**DO NOT** allow children to play with or adjust the pushchair.

**DO NOT** carry more than one child on this pushchair.

**DO NOT** overload the pocket on the back of the hood – this may cause the pushchair to fall backwards.

**DO** support the back of the pushchair seat when reclining it.

**DO** use a correctly fitted and adjusted harness at all times. If using an alternative harness conforming to BS6684, 'D' ring attachments

are found on each side of the pushchair.

**DO** read the labels on the covers for washing instructions and do not tumble dry – drip dry only.

**DO** regularly inspect the pushchair to ensure all parts are in full working order.

**DO** ensure children are clear of moving parts and locking devices while making adjustments.

**DO** periodically check that any screws, nuts, bolts and other fastenings are fully tightened.

**DO** store the pushchair in a safe place when not in use. Avoid placing heavy objects on top of it and do not store near direct heat sources, e.g. radiators, open bar fires or in direct sun light as the cover may fade.

This pushchair is designed and manufactured to comply to EN1888: 2005.

This pushchair is a Type 'A' chassis, and is compatible with other Britax Type 'A' products.

### Guarantee

All Britax products are carefully designed, manufactured and tested. However, should this product prove faulty within six months of purchase due to a materials or manufacturing fault please return it to the original place of purchase. We will then, at our discretion, repair it free of charge.

For guarantee purposes proof of purchase will be required. We recommend that you retain your receipt and attach it to this user guide. They should be kept in a safe place.

Britax does not accept liability for damage arising from abuse, misuse or negligence. This guarantee is not transferable and therefore does not apply to second-hand products.

Your statutory rights are not affected by this guarantee.

# Introducing your new pushchair

Children up to 15kg (approx. 4 years)

## Infant Carrier

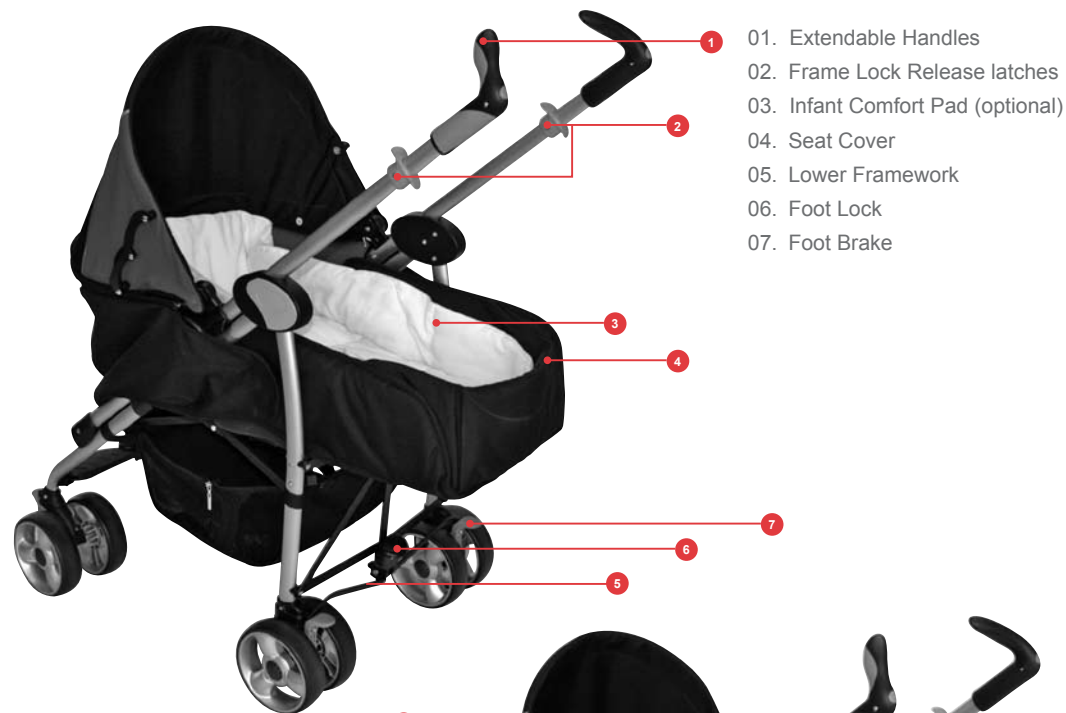

- 01. Extendable Handles
- 02. Frame Lock Release latches
- 03. Infant Comfort Pad (optional)
- 04. Seat Cover
- 05. Lower Framework
- 06. Foot Lock
- 07. Foot Brake

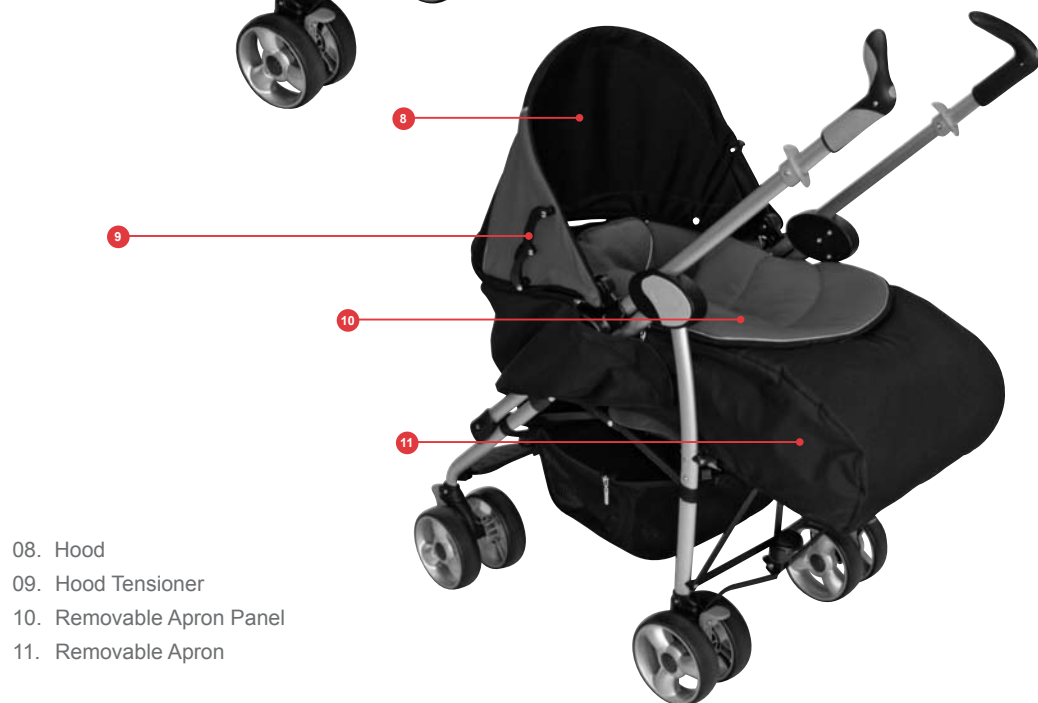

- 08. Hood
- 09. Hood Tensioner
- 10. Removable Apron Panel
- 11. Removable Apron

## Toddler Carrier



- 12. Harness straps
- 13. Arm Rest
- 14. Bumper Bar
- 15. Calf Support
- 16. Calf Support release latches
- 17. Foot rest
- 18. Front swivel wheel lock
- 19. "D" Rings

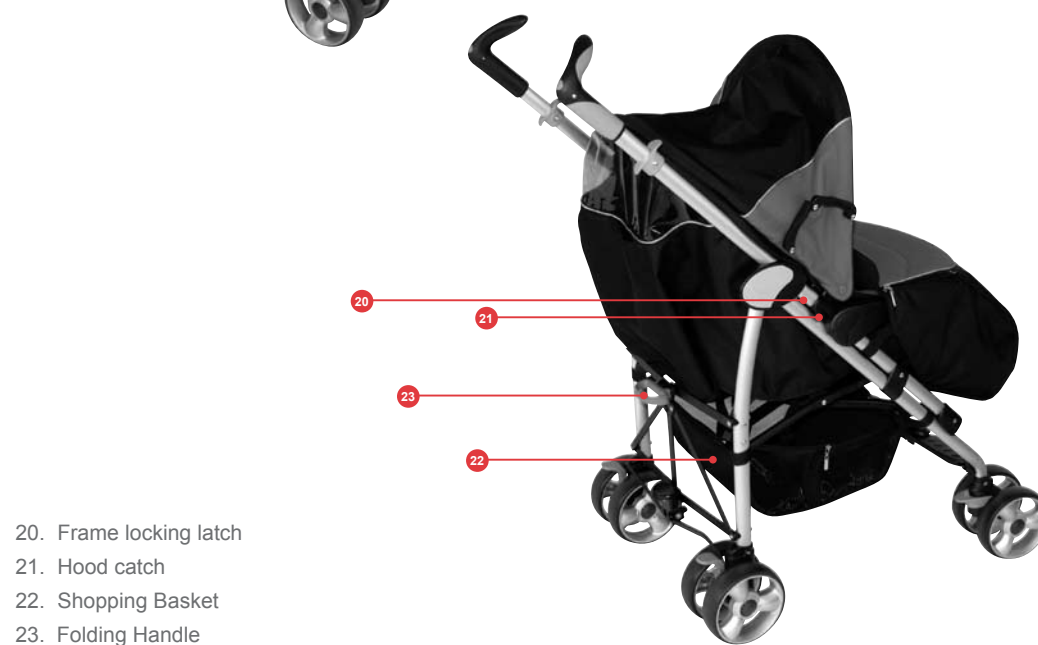

- 20. Frame locking latch
- 21. Hood catch
- 22. Shopping Basket
- 23. Folding Handle

## 1. Assembling your pushchair

Children up to 15kg (approx. 4 years)

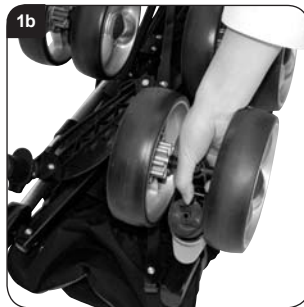
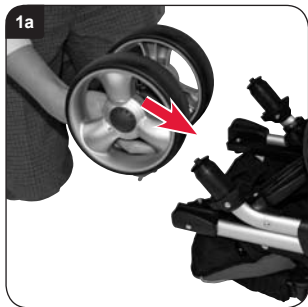

### Fitting and removal of the front swivel wheels

Take each of the front swivel wheel assemblies and press them down onto each of the front legs. You will hear a "click" when they are locked into place (dia 1a).

If you need to remove a front swivel wheel, press the wheel release lever (dia 1b) located on the underside of the wheel and lift the wheel assembly from the front leg.

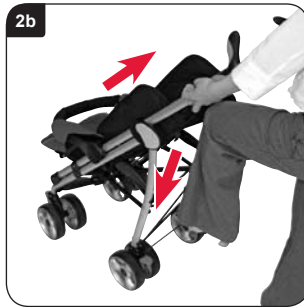

### Unfolding the pushchair

Holding the pushchair in a vertical position, lift up on the lock release latches (dia 2a).

Push down on the foot lock with your foot whilst pulling both handles up firmly, opening the pushchair until the chassis locks into the open position (dia 2b).

Ensure the frame locking latch has locked on both sides.

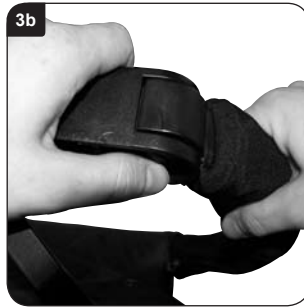
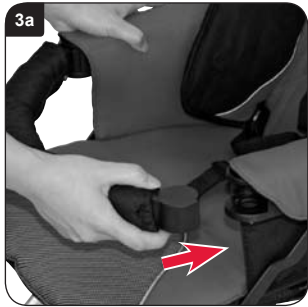

### Fitting the bumper bar

Whilst pressing the button on the bottom of the bumper bar, slide one side of the bar into the armrest socket in the position shown (dia 3a), release the button to engage the lock (dia 3b). Repeat this sequence for the other side.

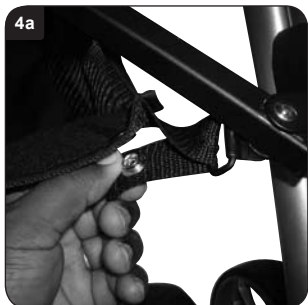

### Attaching the shopping basket

Ensure the basket is fitted with the zips at the sides.

Thread the front press stud straps through the metal loops attached to the front of the frame, press studs together (dia 4a).

Thread the rear press stud straps around the rear legs and above the frame, press studs together (dia 4b).

## 2. Using the functions of your pushchair

Children up to 15kg (approx. 4 years)

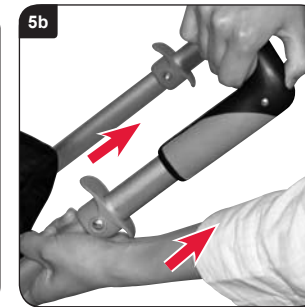
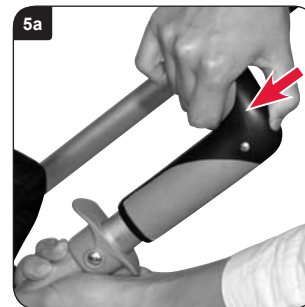

### Extending and retracting the handles

To extend each of the pushchair handles, press the button located at the top of each handle inwards (dia 5a), pull the handles towards you to extend (dia 5b).

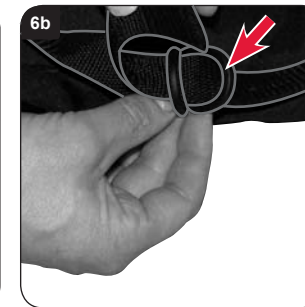
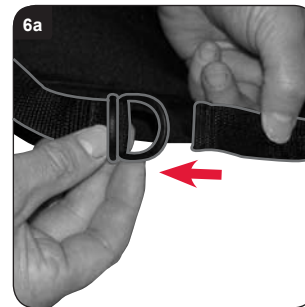

### Threading the underside chassis cover straps

Place the pushchair on its side to gain better access to the underside cover straps.

Thread the loose end of the strap through both D-rings (dia 6a). Thread the strap back over the last D-ring and back through the first D-ring (dia 6b). Pull the strap tight.

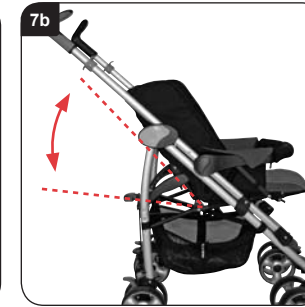

### Adjusting the backrest

Squeeze clips towards each other to release the backrest lock (dia 7a). Move the backrest into the desired position (dia 7b).

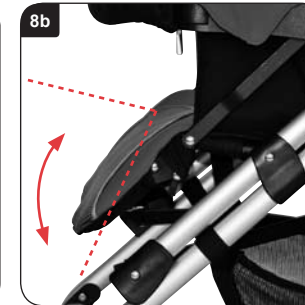
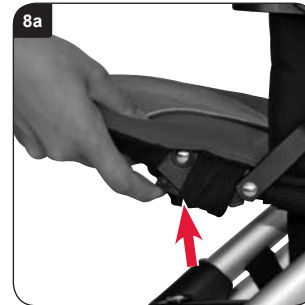

### To adjust the calf support

Lower the calf support by lifting up the release latches located underneath both sides of the calf support (dia 8a) and push the calf support down.

Raise the calf support by lifting it until the release latches lock into place (dia 8b).

## 2. Using the functions of your pushchair, continued

Children up to 15kg (approx. 4 years)



### Using the front swivel wheel locks

To lock the front swivel wheels into the locked position, align front wheels into a straight forward position and slide the wheel lock guide up (dia 9a). To unlock the front wheels, slide front wheel lock guide down (dia 9b).

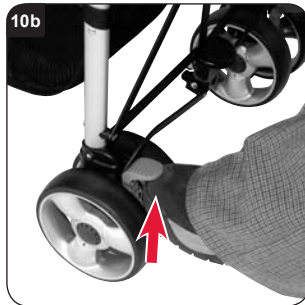

### To use the pushchair brake

**IMPORTANT** - Parking brake is to be used only when pushchair is stopped. **DO NOT** apply the parking brake to a moving pushchair.

**IMPORTANT** - To prevent the pushchair from moving, always use the parking brake when loading/unloading pushchair or making any adjustments. To lock rear wheels for parking or loading pushchair, depress foot brake (dia 10a). To release brake, simply lift up the foot brake to disengage brake from rear wheel hubs (dia 10b).

**IMPORTANT** - Always use the brake pedal, as using the connecting bar will cause it to bend.

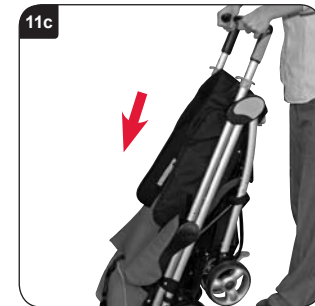

### Folding your pushchair

Lock the front wheels. Position the seat in the front-facing full upright position. Lift up on the lock release latches (dia 11a).

Lift up the lower framework with your foot then pull up on the folding handle to fold the frame (dia 11b).

Hold pushchair vertically and push down on the handles until the latches lock on both sides (you will hear a click) (dia 11c).

## 3. Using your pushchair as an infant pram

Children up to 9kg (or until your child can sit unaided)

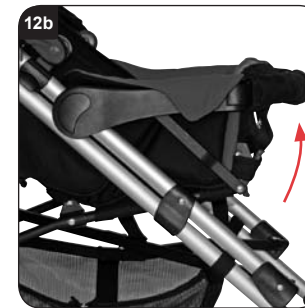

Open the bumper bar (see dia 3a and 3b). Raise the calf support to the upright position (dia 12a and 12b). Close the bumper bar on the outside with the calf support on the inside.



Lower the backrest into the infant carrier position (lowest position) (dia 12c) by squeezing and pulling the adjustment handle upwards. (dia 12d).



For your child's comfort, unfasten the harness and move them away to the side of the pushchair (dia 12e).

Insert the optional infant comfort pad or mattress in the position shown (dia 12f). The magnets will hold the infant comfort pad in position.

The D-rings can be used to attach your own harness.

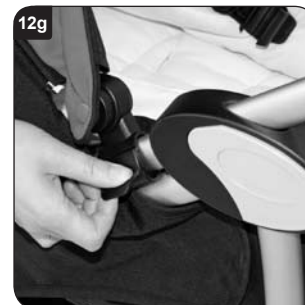

Place the hood in the correct position (with the window at front of pushchair) over the pushchair. Attach the hood clip to each side of the pushchair frame by locating the clips over the top of the upper tube first, then pushing until they click into place. (dia 12g).

Open the hood by pulling the front of the canopy forwards engaging the hood tensioners on each side to click in place (dia 12h).

### 3. Using your pushchair as an infant pram, continued

Children up to 9kg (or until your child can sit unaided)



Place the optional apron over the frame as shown (dia 12i).

On each side fold the 'hook and loop strap' back onto itself, and tuck inside the apron. Attach the remaining hook fastenings on both sides of the apron to the loop fastenings on each side of the seat cover (dia 12j). The loop fastenings on the seat cover should be shared by the hook fastenings on both the apron and canopy.

### 4. Using your pushchair with an infant carrier

Children up to 13kg (approx. 1 year)

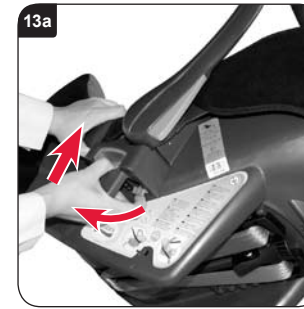

Ensure that the left hand and right hand adaptors are used on the correct side of the child seat.

To fit the adaptor to the child seat squeeze the lever and insert into the space below the handle (dia 13a). Make sure it is fully fitted and release the lever to lock into place. Repeat this process for both adaptors.

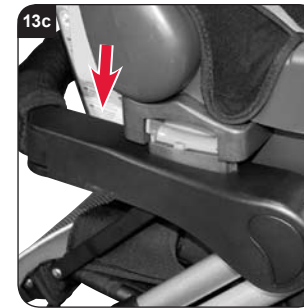

#### Fitting the infant carrier

First unfold the armrest covers (please see dia 15a).

Lower the infant carrier (will be labelled 'Type V, A, B, W') onto the armrests in the orientation shown (dia 13b), making sure that the prongs either side drop into both slots on each armrest. Push down firmly. Once the infant carrier is engaged you will hear a click.

Lower the infant carrier handle to the safety stop position. Please refer to the user guide for the infant carrier.

**WARNING** – Check that the attachment devices are correctly engaged before use.

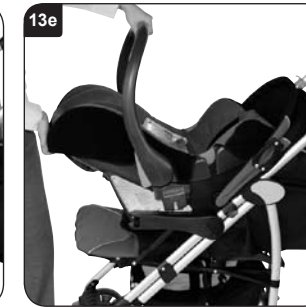

#### Removing the infant carrier

To remove the infant carrier, move the handle to the carrying position.

Please refer to the user guide for the infant carrier.

Pull up the release levers on each side (dia 13d) and lift the infant carrier out of the sockets (dia 13e).

The infant carrier is now ready for use. Re-attach the armrest pads after use.

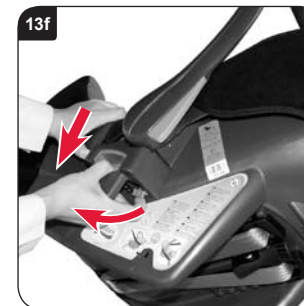

#### Removing the adaptors

To remove the adaptors from the child seat, pull the lever on the adaptors away from the child seat while pulling down (dia 13f). Repeat the process for both adaptors.

#### IMPORTANT -

It may be necessary to remove the adaptors from the child seat when installing it in your vehicle. If the adaptors are in contact with the vehicle seat cushion, remove them.

## 5. Using your pushchair for carrying a toddler

Children up to 15kg (approx. 4 years)

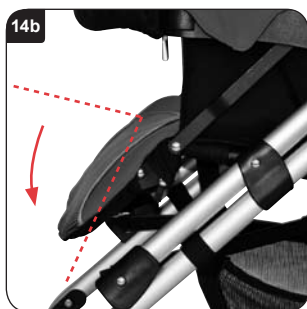

Lower the leg support into the toddler carrying position (dia 14a and 14b).

Note: The bumper bar may need to be removed during this procedure.



Raise the backrest into the toddler carrying position (upright position) (dia 14c) by squeezing and pulling the adjustment handle upwards.



Unfasten the harness and insert the optional infant comfort pad in the position shown, rethread the harness through the slots in the infant pad (dia 14e and 14f).

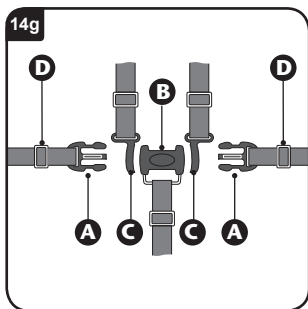

### To secure your child

A five-point harness is provided to restrain your child (dia 14g). To secure the child in the harness, push buckle **A** through **C** and into **B** until the buckle prongs snap into position. Carefully adjust the harness by pulling the slider **D** until the desired fit is achieved in the waist belt, shoulder and crotch straps.

Always adjust the harness when changing the seating position of the child.

To release the buckle, squeeze the top and bottom prongs.

**WARNING** – Always use the crotch strap in combination with the waist belt.

**WARNING** – Fasten the harness when not in use to prevent it becoming trapped when folding the pushchair. “D” rings are provided at each side of the seat for attachment of an alternative harness.

## 5. Using your pushchair for carrying a toddler, continued

Children up to 15kg (approx. 4 years)



Place the hood in the correct position (with window at rear of pushchair) over the pushchair. Attach the hood clip to each side of the pushchair frame by locating the clips over the top of the upper tube first, then pushing until they click into place. (dia 14h).

Open the hood by pulling the front of the canopy forwards engaging the hood tensioners on each side to lock it in place (dia 14i).



Attach the optional apron in the toddler position, place the apron over the frame as shown (dia 14j). Attach the hook and loop straps on each side around the pushchair chassis, threading straps between the tubes as shown (dia 14k).

## 6. Removing and refitting the covers and harness

Children up to 15kg (approx. 4 years)



### Unfolding the armrest pads

To unfold the armrest pads, pull down on the fabric on the outer side and fold into the centre of the pushchair (dia 15a).



### Removing the bumper bar cover

To remove the bumper bar cover, simply unzip the bumper bar cover and remove from the plastic moulding (dia 15b).



### Removing the shopping basket

Remove the press studs located at the rear (dia 15c) and the front (dia 15d) of the shopping basket.

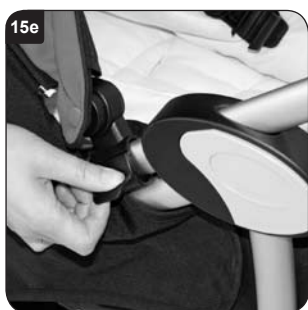

### Removing the canopy hood

Pull the hood clips off the bars located just above the armrest (dia 15e).

## 6. Removing and refitting the covers and harness, continued

Children up to 15kg (approx. 4 years)



### To remove the infant pad

Unthread the harness (if it's in the toddler carrying position) (dia 15f).

To refit the infant pad simply place the infant pad in the pushchair, thread the harness back through then use the magnets to keep it in place.



### To remove the optional removable apron.

Unfasten the hook loops on both sides of the seat (dia 15g) then pull the apron off (dia 15h).



### Removing the main chassis cover

Unthread the underside cover straps (dia 15j).

Unhook the cover from under the calf support by pulling up in the direction shown (dia 15k).

The chassis cover can now be lifted from the pushchair frame (dia 15l and m) and the harness released from the chassis cover.

To refit all the covers, simply reverse the above instructions.





**Britax Excelsior Limited**

1 Churchill Way West  
Andover  
Hampshire SP10 3UW  
United Kingdom  
Tel: 01264 386034  
[www.britax.eu](http://www.britax.eu)

Britax is a registered trademark of Britax Childcare

AZ0-048

